

Article number: 12309000140100
Description: KLEE-coil 309 000 140.100
M14 Unhardened steel

Measures

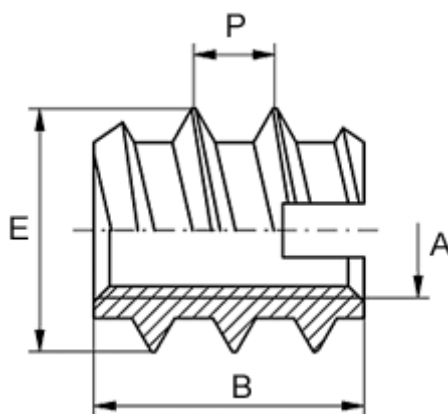

Female thread A	= M14
Length B	= 26
Male thread E	= 22.0
Min hole depth	= 30
Recommended bore diameter (plastic/hard wood)	= 18.6 to 18.8
Recommended bore diameter, soft wood (largest)	= 18.0
Thread pitch P	= 5.0